



VNS3NV04D-E

OMNIFET II fully autoprotected Power MOSFET

Features

Max On-State resistance (per ch.)	R_{ON}	120m Ω
Current limitation (typ)	I_{LIMH}	3.5A
Drain-Source clamp voltage	V_{CLAMP}	40V

- Linear current limitation
- Thermal shut down
- Short circuit protection
- Integrated clamp
- Low current drawn from input pin
- Diagnostic feedback through input pin
- ESD protection
- Direct access to the gate of the power mosfet (analog driving)
- Compatible with standard power mosfet

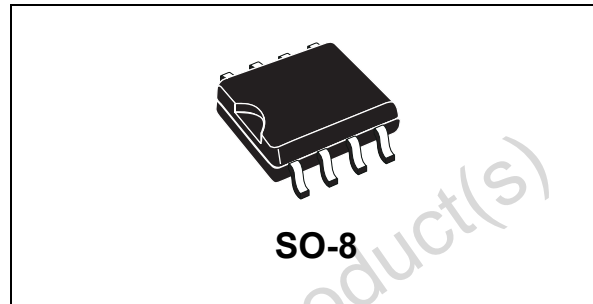

Description

The VNS3NV04D-E is a device formed by two monolithic OMNIFET II chips housed in a standard SO-8 package. The OMNIFET II are designed in STMicroelectronics VIPower M0-3 Technology: they are intended for replacement of standard Power MOSFETS from DC up to 50KHz applications. Built in thermal shutdown, linear current limitation and overvoltage clamp protects the chip in harsh environments.

Fault feedback can be detected by monitoring the voltage at the input pin.

Table 1. Device summary

Package	Tube	Tape and Reel
SO-8	VNS3NV04D-E	VNS3NV04DTR-E

Contents

1	Block diagram and pin description	5
2	Electrical specifications	6
2.1	Absolute maximum ratings	6
2.2	Thermal data	7
2.3	Electrical characteristics	7
2.4	Electrical characteristics curves	12
3	Protection features	16
3.1	Overvoltage clamp protection	16
3.2	Linear current limiter circuit	16
3.3	Overtemperature and short circuit protection	16
3.4	Status feedback	16
4	Package and packing information	17
4.1	ECOPACK® packages	17
4.2	SO-8 Package mechanical data	18
4.3	SO-8 Packing information	19
5	Revision history	20

List of tables

Table 1.	Device summary	1
Table 2.	Absolute maximum ratings	6
Table 3.	Thermal data	7
Table 4.	Off	7
Table 5.	On	7
Table 6.	Dynamic	8
Table 7.	Switching	8
Table 8.	Source Drain diode	8
Table 9.	Protections (-40°C < T _j < 150°C, unless otherwise specified)	9
Table 10.	Document revision history	20

Obsolete Product(s) - Obsolete Product(s)

List of figures

Figure 1.	Block diagram	5
Figure 2.	Configuration diagram (top view)	5
Figure 3.	Current and voltage conventions	6
Figure 4.	Switching time test circuit for resistive load	9
Figure 5.	Test circuit for diode recovery times	10
Figure 6.	Unclamped inductive load test circuits	10
Figure 7.	Input charge test circuit.	11
Figure 8.	Unclamped inductive waveforms	11
Figure 9.	Source-Drain diode forward characteristics	12
Figure 10.	Static Drain-Source On resistance	12
Figure 11.	Derating curve	12
Figure 12.	Static Drain-Source On resistance vs. Input voltage	12
Figure 13.	Static Drain-Source On resistance Vs. Input voltage	12
Figure 14.	Transconductance	12
Figure 15.	Static Drain-Source On resistance Vs. Id	13
Figure 16.	Transfer characteristics	13
Figure 17.	Turn On current slope	13
Figure 18.	Turn On current slope	13
Figure 19.	Input voltage Vs. Input charge	13
Figure 20.	Turn off Drain source voltage slope	13
Figure 21.	Turn off Drain-Source voltage slope	14
Figure 22.	Capacitance variations	14
Figure 23.	Switching time resistive load.	14
Figure 24.	Switching time resistive load.	14
Figure 25.	Output characteristics	14
Figure 26.	Normalized On resistance Vs. temperature	14
Figure 27.	Normalized Input threshold voltage Vs. temperature	15
Figure 28.	Normalized current limit Vs. junction temperature	15
Figure 29.	Step response current limit	15
Figure 30.	SO-8 Package mechanical data & package outline	18
Figure 31.	SO-8 Tube shipment (no suffix)	19
Figure 32.	SO-8 Tape and reel shipment (suffix "TR")	19

1 Block diagram and pin description

Figure 1. Block diagram

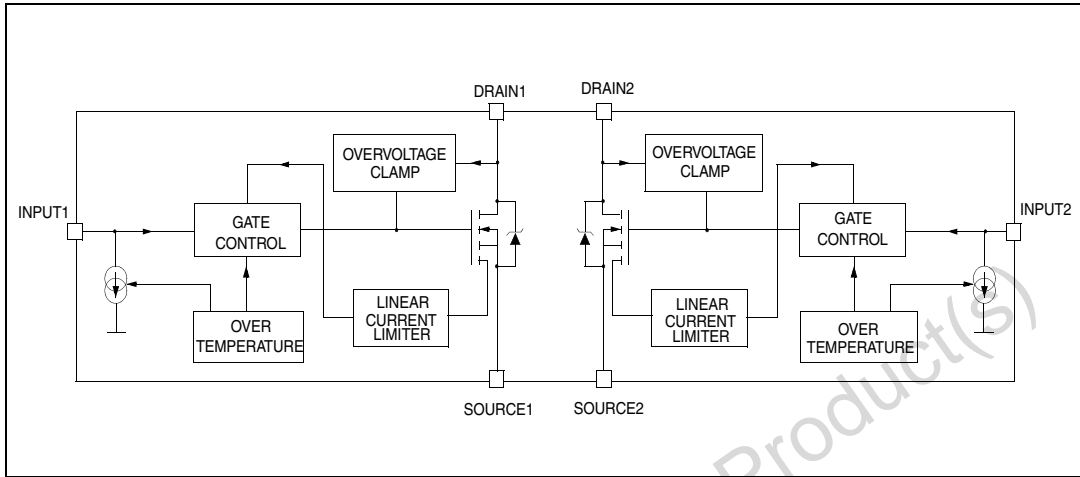
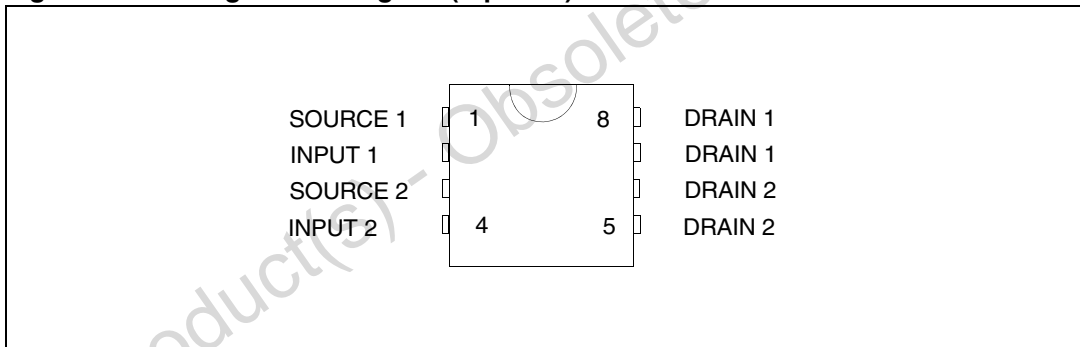
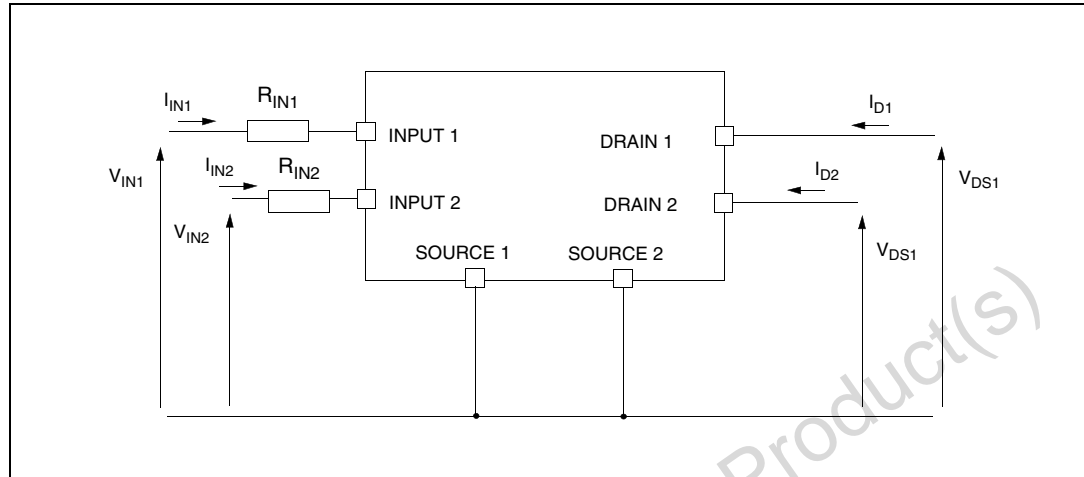

Figure 2. Configuration diagram (top view)



2 Electrical specifications

Figure 3. Current and voltage conventions



2.1 Absolute maximum ratings

Stressing the device above the rating listed in the “Absolute maximum ratings” table may cause permanent damage to the device. These are stress ratings only and operation of the device at these or any other conditions above those indicated in the operating sections of this specification is not implied. Exposure to Absolute maximum rating conditions for extended periods may affect device reliability. Refer also to the STMicroelectronics SURE program and other relevant quality document.

Table 2. Absolute maximum ratings

Symbol	Parameter	Value	Unit
V_{DSn}	Drain-Source Voltage ($V_{INn}=0V$)	Internally clamped	V
V_{INn}	Input voltage	Internally clamped	V
I_{INn}	Input current	+/-20	mA
$R_{IN\ MINn}$	Minimum input series impedance	220	Ω
I_{Dn}	Drain current	Internally limited	A
I_{Rn}	Reverse DC output current	-5.5	A
V_{ESD1}	Electrostatic discharge ($R=1.5K\Omega$, $C=100pF$)	4000	V
V_{ESD2}	Electrostatic discharge on output pins only ($R=330\Omega$, $C=150pF$)	16500	V
P_{tot}	Total dissipation at $T_c=25^\circ C$	4	Ω
T_j	Operating junction temperature	Internally limited	$^\circ C$
T_c	Case operating temperature	Internally limited	$^\circ C$
T_{stg}	Storage temperature	-55 to 150	$^\circ C$

2.2 Thermal data

Table 3. Thermal data

Symbol	Parameter	Max value	Unit
$R_{thj-lead}$	Thermal resistance junction-lead (per channel)	30	°C/W
$R_{thj-amb}$	Thermal resistance junction-ambient	80 ⁽¹⁾	°C/W

1. When mounted on a standard single-sided FR4 board with 50mm² of Cu (at least 35 μm thick) connected to all DRAIN pins of the relative channel

2.3 Electrical characteristics

Values specified in this section are for $-40^{\circ}\text{C} < T_j < 150^{\circ}\text{C}$, unless otherwise stated.

Table 4. Off

Symbol	Parameter	Test Conditions	Min	Typ	Max	Unit
V_{CLAMP}	Drain-Source clamp voltage	$V_{IN}=0V; I_D=1.5A$	40	45	55	V
V_{CLTH}	Drain-Source clamp threshold voltage	$V_{IN}=0V; I_D=2mA$	36			V
V_{INTH}	Input threshold voltage	$V_{DS}=V_{IN}; I_D=1mA$	0.5		2.5	V
I_{ISS}	Supply current from input pin	$V_{DS}=0V; V_{IN}=5V$		100	150	μA
V_{INCL}	Input-Source clamp voltage	$I_{IN}=1mA$ $I_{IN}=-1mA$	6 -1.0	6.8	8 -0.3	V
I_{DSS}	Zero input voltage drain current ($V_{IN}=0V$)	$V_{DS}=13V; V_{IN}=0V; T_j=25^{\circ}\text{C}$ $V_{DS}=25V; V_{IN}=0V$			30 75	μA

Table 5. On

Symbol	Parameter	Test conditions	Min	Typ	Max	Unit
$R_{DS(on)}$	Static Drain-Source On resistance	$V_{IN}=5V; I_D=1.5A; T_j=25^{\circ}\text{C}$ $V_{IN}=5V; I_D=1.5A$			120 240	mΩ

Electrical characteristics (continued) ($T_j=25^\circ\text{C}$, unless otherwise specified)**Table 6. Dynamic**

Symbol	Parameter	Test conditions	Min	Typ	Max	Unit
$g_{fs}^{(1)}$	Forward transconductance	$V_{DD}=13\text{V}; I_D=1.5\text{A}$		5.0		S
C_{OSS}	Output capacitance	$V_{DS}=13\text{V}; f=1\text{MHz}; V_{IN}=0\text{V}$		150		pF

Table 7. Switching

Symbol	Parameter	Test conditions	Min	Typ	Max	Unit
$t_{d(on)}$	Turn-on delay time	$V_{DD}=15\text{V}; I_D=1.5\text{A}$ $V_{gen}=5\text{V}; R_{gen}=R_{IN\ MIN}=220\Omega$ (see Figure 4)		90	300	ns
t_r	Rise Time			250	750	ns
$t_{d(off)}$	Turn-off delay time			450	1350	ns
t_f	Fall time			250	750	ns
$t_{d(on)}$	Turn-on delay time	$V_{DD}=15\text{V}; I_D=1.5\text{A}$ $V_{gen}=5\text{V}; R_{gen}=2.2\ \text{K}\Omega$ (see Figure 4)		0.45	1.35	μs
t_r	Rise time			2.5	7.5	μs
$t_{d(off)}$	Turn-off delay time			3.3	10.0	μs
t_f	Fall time			2.0	6.0	μs
$(di/dt)_{on}$	Turn-on current slope	$V_{DD}=15\text{V}; I_D=1.5\text{A}$ $V_{gen}=5\text{V}; R_{gen}=R_{IN\ MIN}=220\Omega$		4.7		$\text{A}/\mu\text{s}$
Q_i	Total input charge	$V_{DD}=12\text{V}; I_D=1.5\text{A}; V_{IN}=5\text{V}$ $I_{gen}=2.13\text{mA}$ (see Figure 7)		8.5		nC

Table 8. Source Drain diode

Symbol	Parameter	Test Conditions	Min	Typ	Max	Unit	
$V_{SD}^{(1)}$	Forward On voltage	$I_{SD}=1.5\text{A}; V_{IN}=0\text{V}$		0.8		V	
t_{rr}	Reverse recovery time	$I_{SD}=1.5\text{A}; di/dt=12\text{A}/\mu\text{s}$ $V_{DD}=30\text{V}; L=200\mu\text{H}$ (see Figure 5)		107		ns	
Q_{rr}	Reverse recovery charge				37		μC
I_{RRM}	Reverse recovery current				0.7		A

1. Pulsed: Pulse duration = 300 μs , duty cycle 1.5%

Table 9. Protections (-40°C < T_j < 150°C, unless otherwise specified)

Symbol	Parameter	Test Conditions	Min	Typ	Max	Unit
I _{lim}	Drain current limit	V _{IN} =5V; V _{DS} =13V	3.5	5	7	A
t _{dlim}	Step response current limit	V _{IN} =5V; V _{DS} =13V		10		μs
T _{jsh}	Overtemperature shutdown		150	175	200	°C
T _{jrs}	Overtemperature reset		135			°C
I _{gf}	Fault sink current	V _{IN} =5V; V _{DS} =13V; T _j =T _{jsh}	10	15	20	mA
E _{as}	Single pulse avalanche energy	Starting T _j =25°C; V _{DD} =24V V _{IN} =5V R _{gen} =R _{IN} MIN=220Ω; L=24mH (see Figure 6 and Figure 8)	100			mJ

Figure 4. Switching time test circuit for resistive load

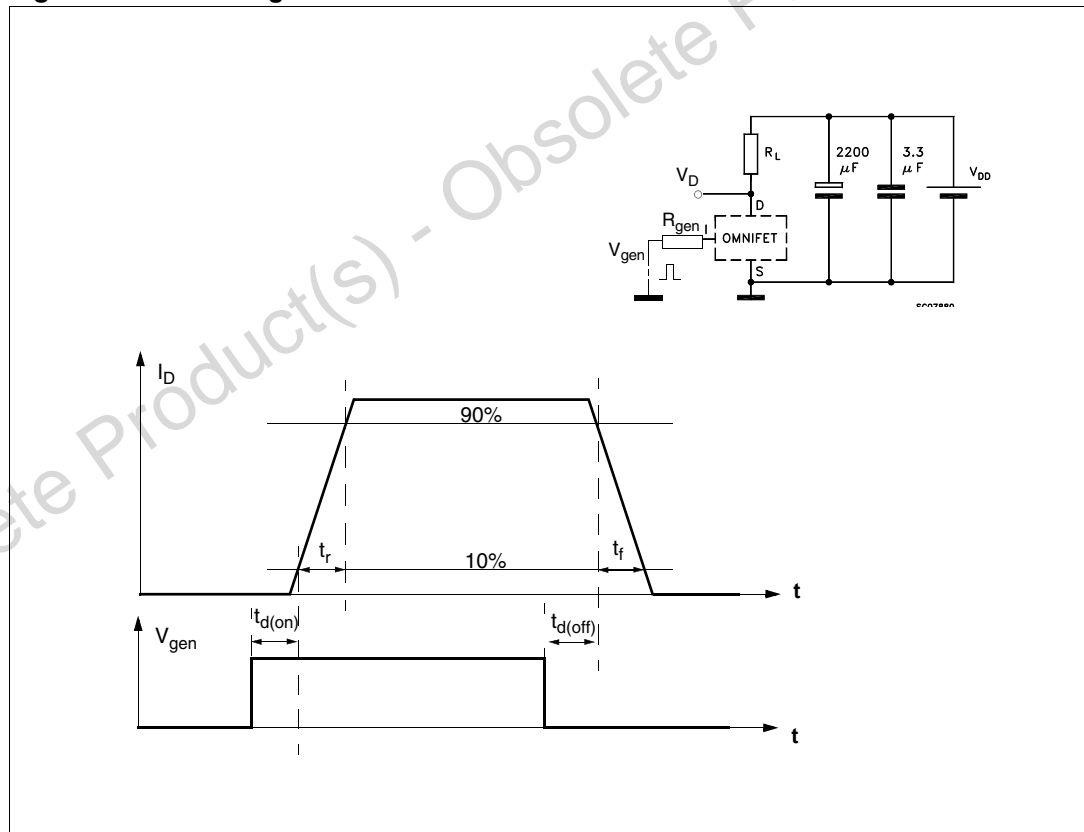

Figure 5. Test circuit for diode recovery times

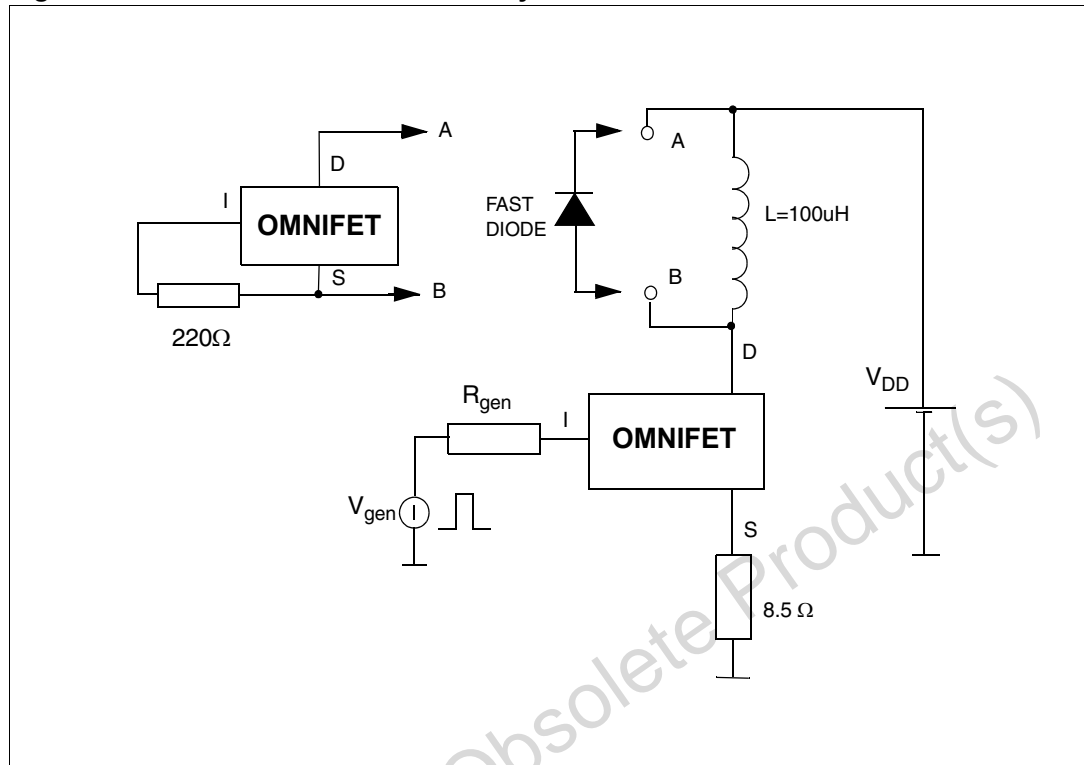
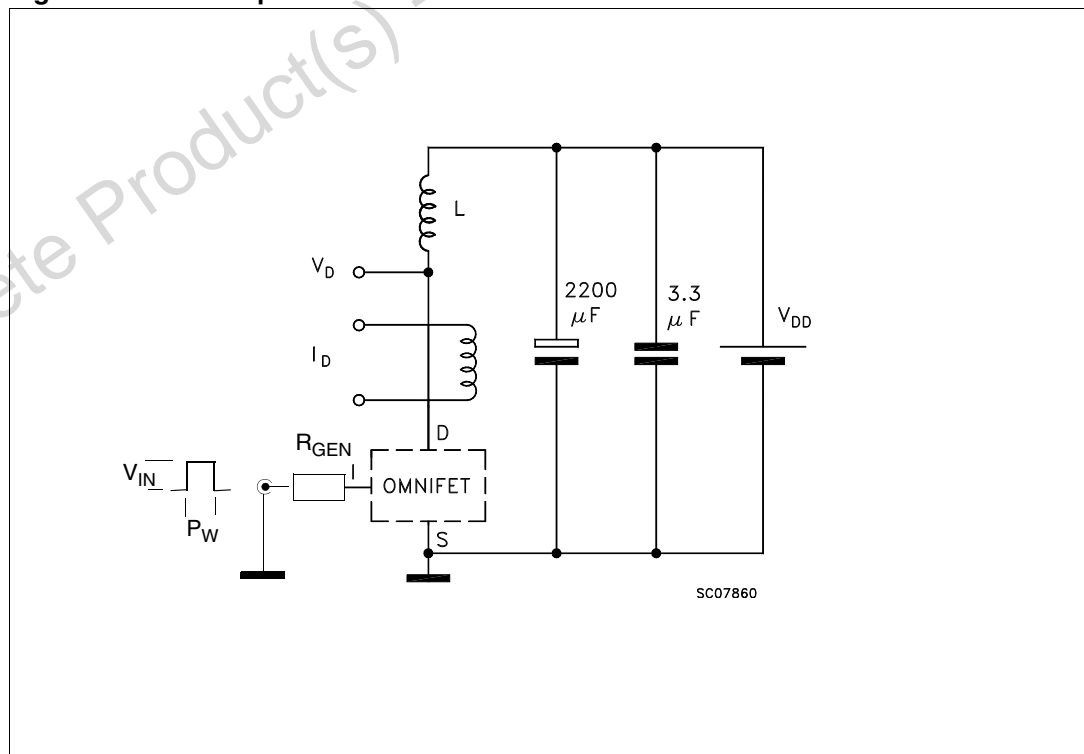

Figure 6. Unclamped inductive load test circuits



2.4 Electrical characteristics curves

Figure 9. Source-Drain diode forward characteristics

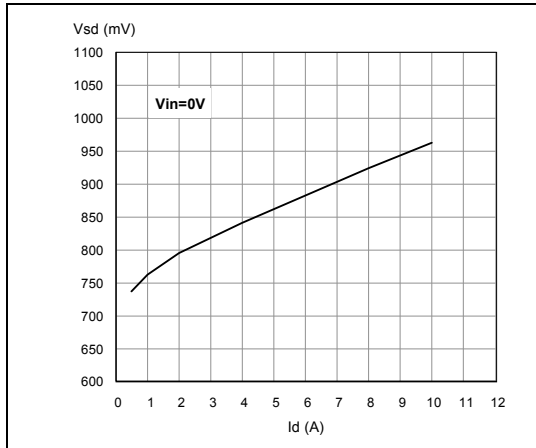

Figure 10. Static Drain-Source On resistance

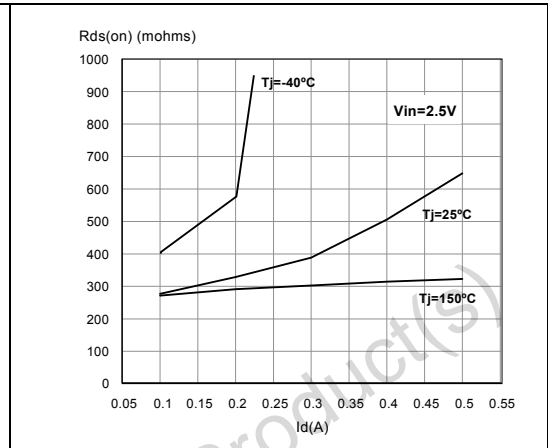

Figure 11. Derating curve

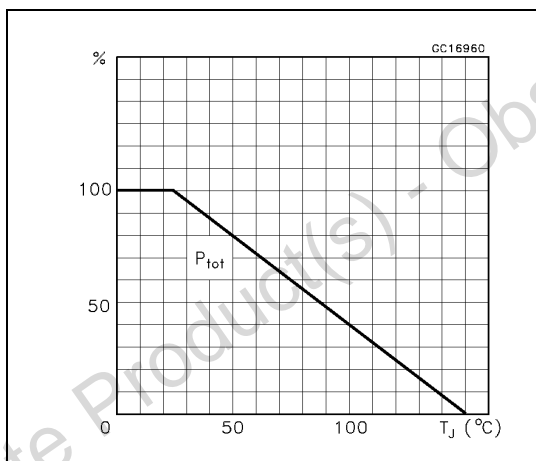

Figure 12. Static Drain-Source On resistance vs. Input voltage

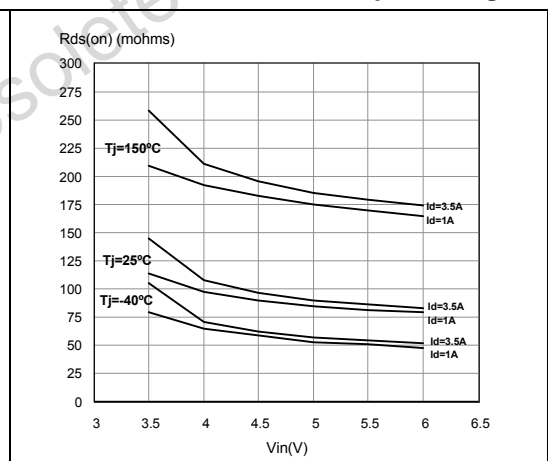

Figure 13. Static Drain-Source On resistance Vs. Input voltage

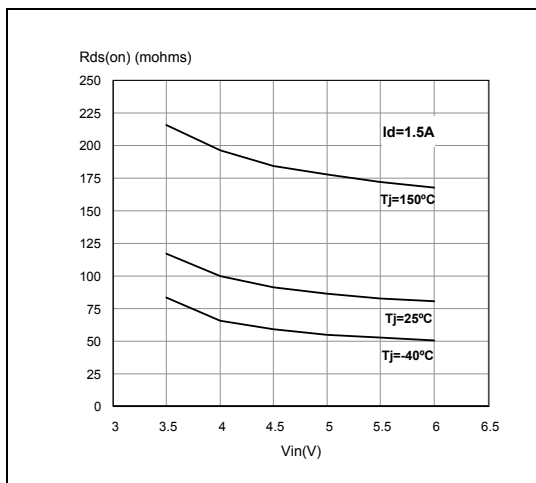

Figure 14. Transconductance

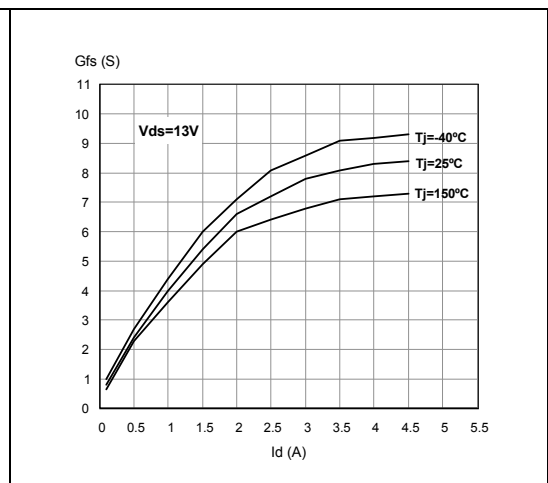

Figure 15. Static Drain-Source On resistance Vs. Id

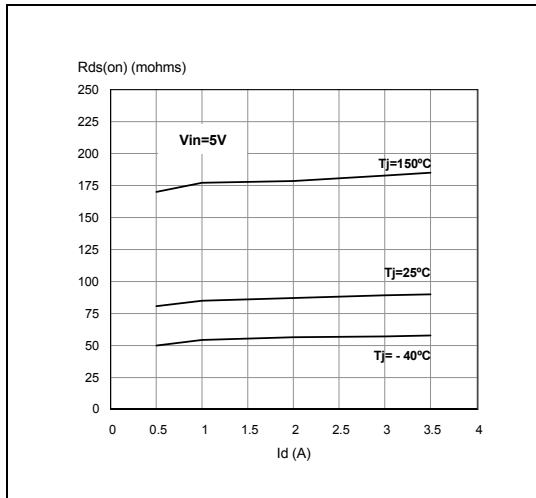

Figure 16. Transfer characteristics

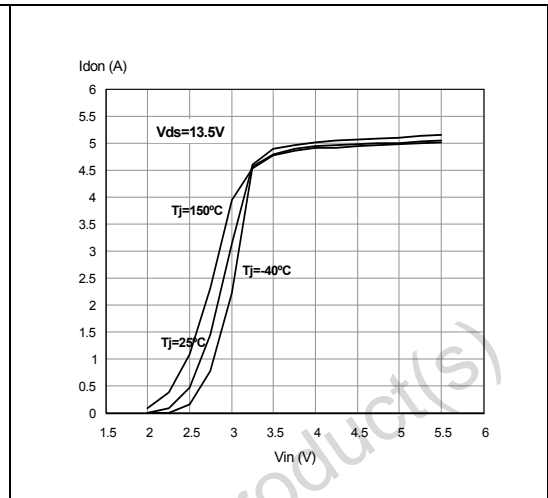

Figure 17. Turn On current slope

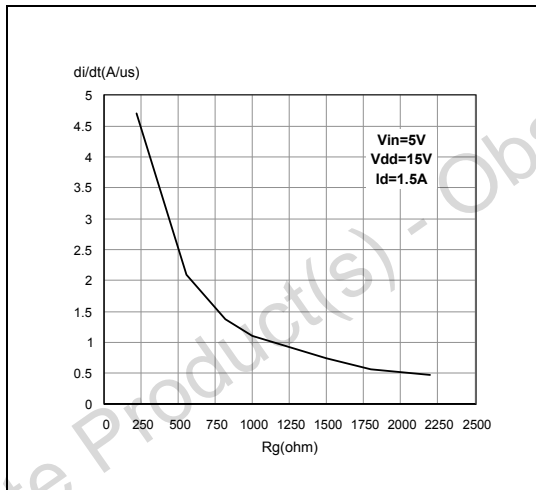

Figure 18. Turn On current slope

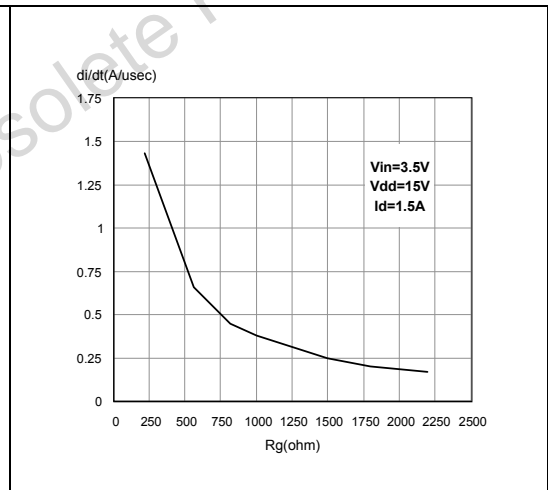

Figure 19. Input voltage Vs. Input charge

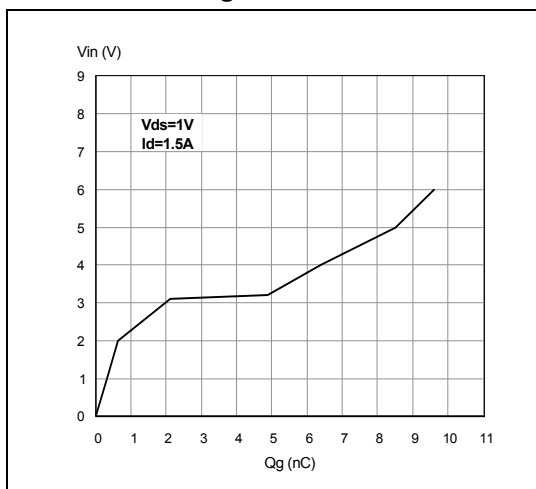

Figure 20. Turn off Drain source voltage slope

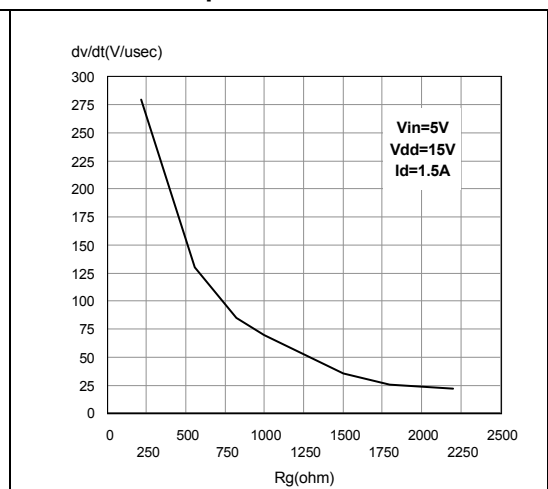

Figure 21. Turn off Drain-Source voltage slope **Figure 22. Capacitance variations**

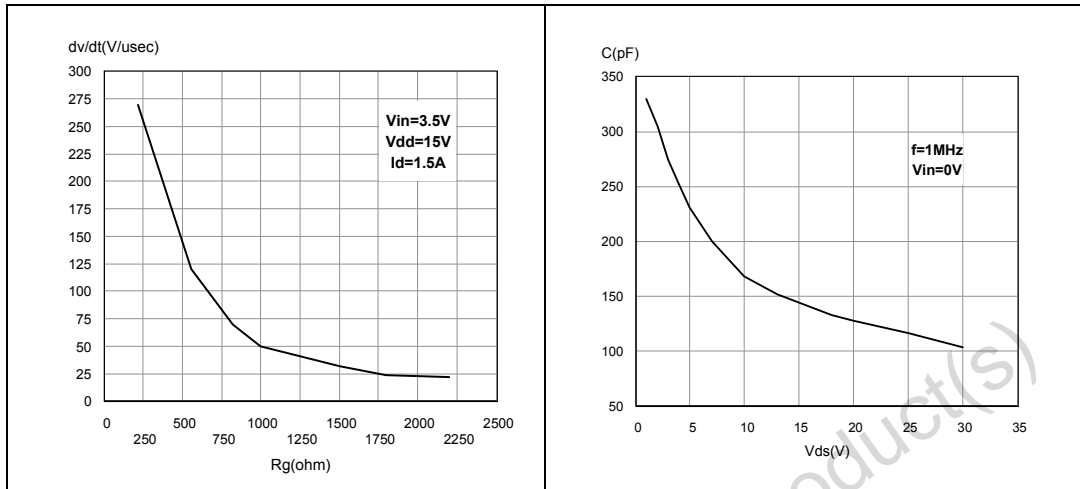

Figure 23. Switching time resistive load **Figure 24. Switching time resistive load**

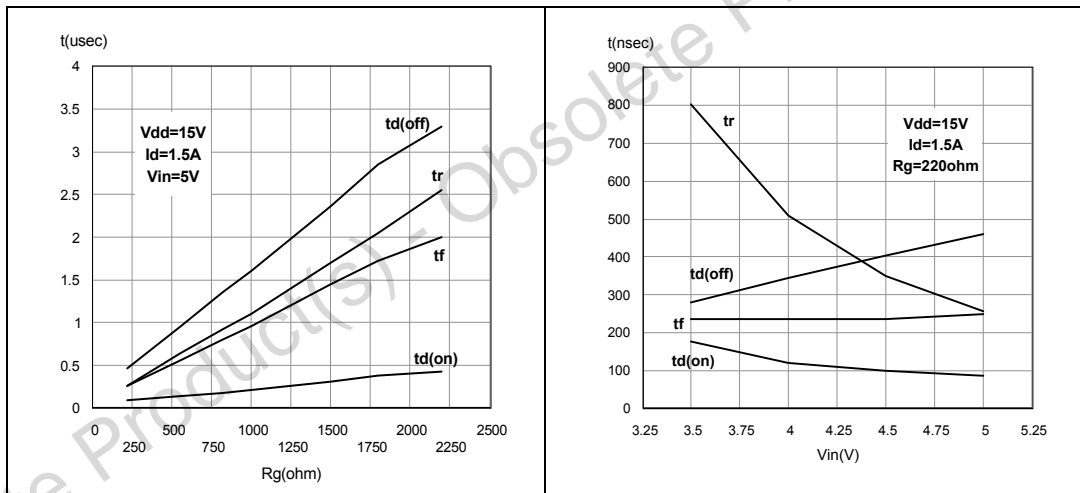

Figure 25. Output characteristics

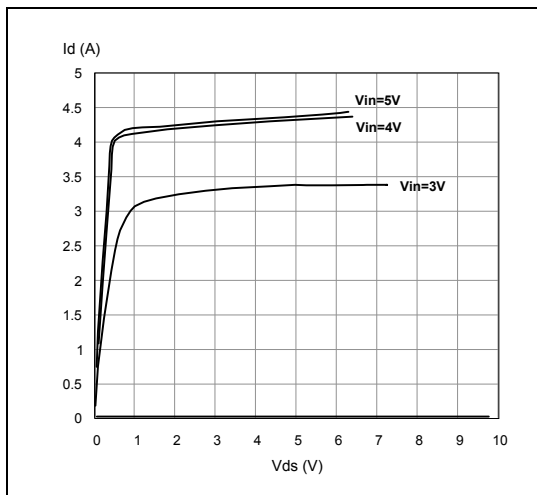

Figure 26. Normalized On resistance Vs. temperature

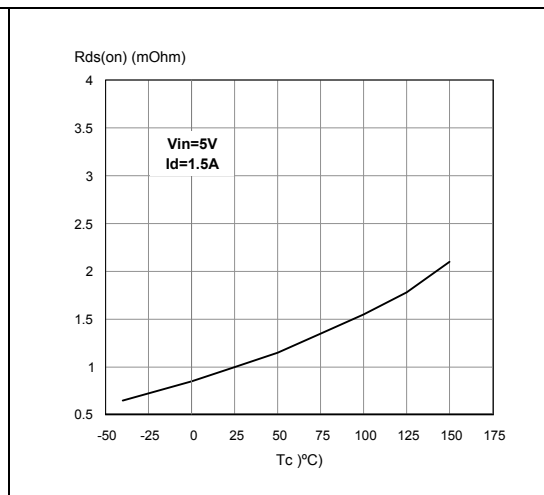

Figure 27. Normalized Input threshold voltage Vs. temperature

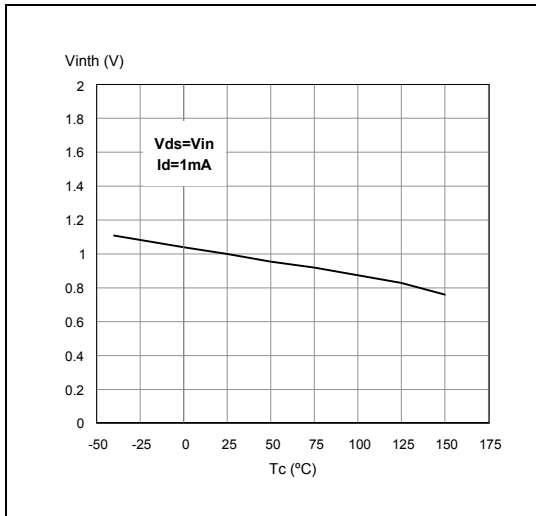

Figure 28. Normalized current limit Vs. junction temperature

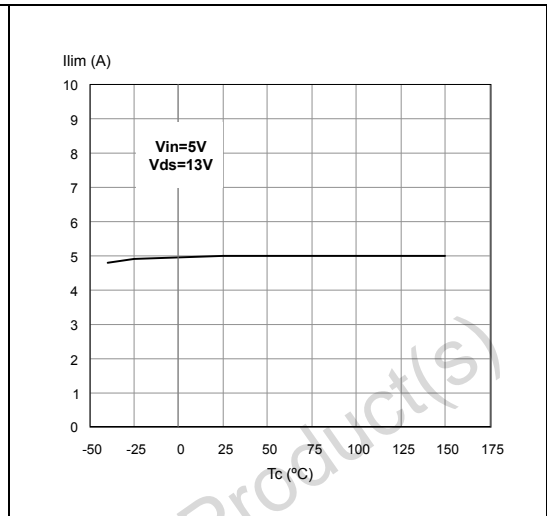
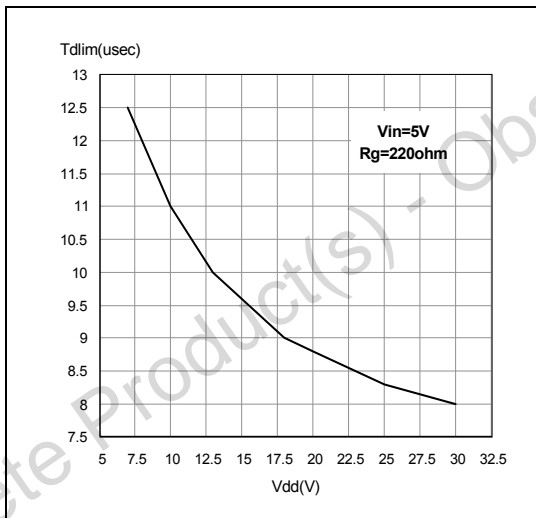

Figure 29. Step response current limit



3 Protection features

During normal operation, the INPUT pin is electrically connected to the gate of the internal power MOSFET through a low impedance path.

The device then behaves like a standard power MOSFET and can be used as a switch from DC up to 50KHz. The only difference from the user's standpoint is that a small DC current I_{ISS} (typ. 100 μ A) flows into the INPUT pin in order to supply the internal circuitry.

The device integrates:

3.1 Overvoltage clamp protection

Internally set at 45V, along with the rugged avalanche characteristics of the Power MOSFET stage give this device unrivalled ruggedness and energy handling capability. This feature is mainly important when driving inductive loads.

3.2 Linear current limiter circuit

Limits the drain current I_D to I_{lim} whatever the INPUT pin voltages. When the current limiter is active, the device operates in the linear region, so power dissipation may exceed the capability of the heatsink. Both case and junction temperatures increase, and if this phase lasts long enough, junction temperature may reach the overtemperature threshold T_{jsh} .

3.3 Overtemperature and short circuit protection

These are based on sensing the chip temperature and are not dependent on the input voltage. The location of the sensing element on the chip in the power stage area ensures fast, accurate detection of the junction temperature. Overtemperature cutout occurs in the range 150 to 190 °C, a typical value being 170 °C. The device is automatically restarted when the chip temperature falls of about 15°C below shut-down temperature.

3.4 Status feedback

In the case of an overtemperature fault condition ($T_j > T_{jsh}$), the device tries to sink a diagnostic current I_{gf} through the INPUT pin in order to indicate fault condition. If driven from a low impedance source, this current may be used in order to warn the control circuit of a device shutdown. If the drive impedance is high enough so that the INPUT pin driver is not able to supply the current I_{gf} , the INPUT pin will fall to 0V. **This will not however affect the device operation: no requirement is put on the current capability of the INPUT pin driver except to be able to supply the normal operation drive current I_{ISS} .**

Additional features of this device are ESD protection according to the Human Body model and the ability to be driven from a TTL Logic circuit.

4 Package and packing information

4.1 ECOPACK® packages

In order to meet environmental requirements, ST offers these devices in ECOPACK® packages. These packages have a Lead-free second-level interconnect. The category of Second-Level Interconnect is marked on the package and on the inner box label, in compliance with JEDEC Standard JESD97. The maximum ratings related to soldering conditions are also marked on the inner box label.

ECOPACK is an ST trademark. ECOPACK specifications are available at: www.st.com.

Obsolete Product(s) - Obsolete Product(s)

4.2 SO-8 Package mechanical data

Figure 30. SO-8 Package mechanical data & package outline

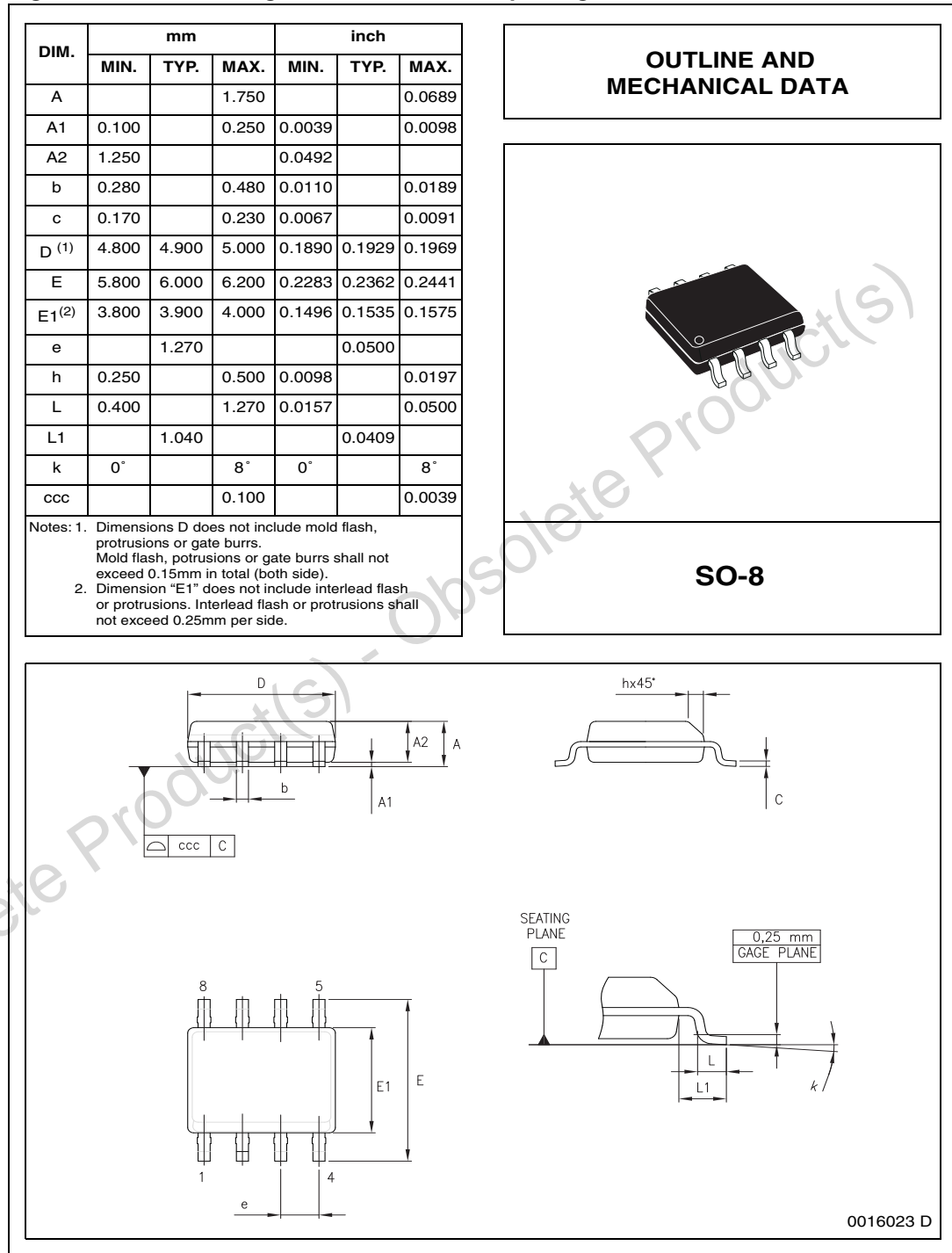

4.3 SO-8 Packing information

Figure 31. SO-8 Tube shipment (no suffix)

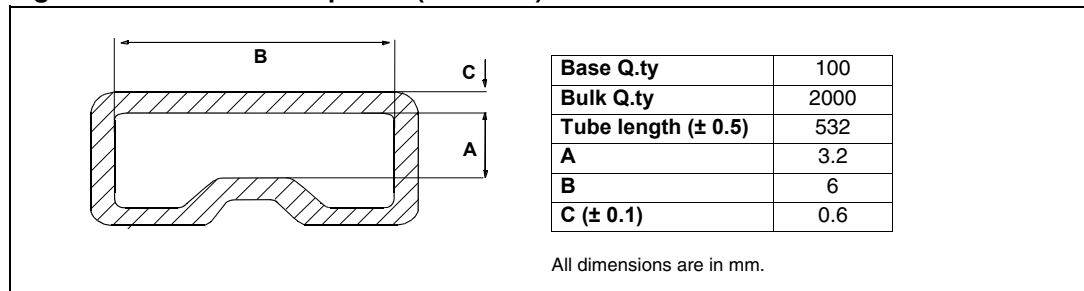
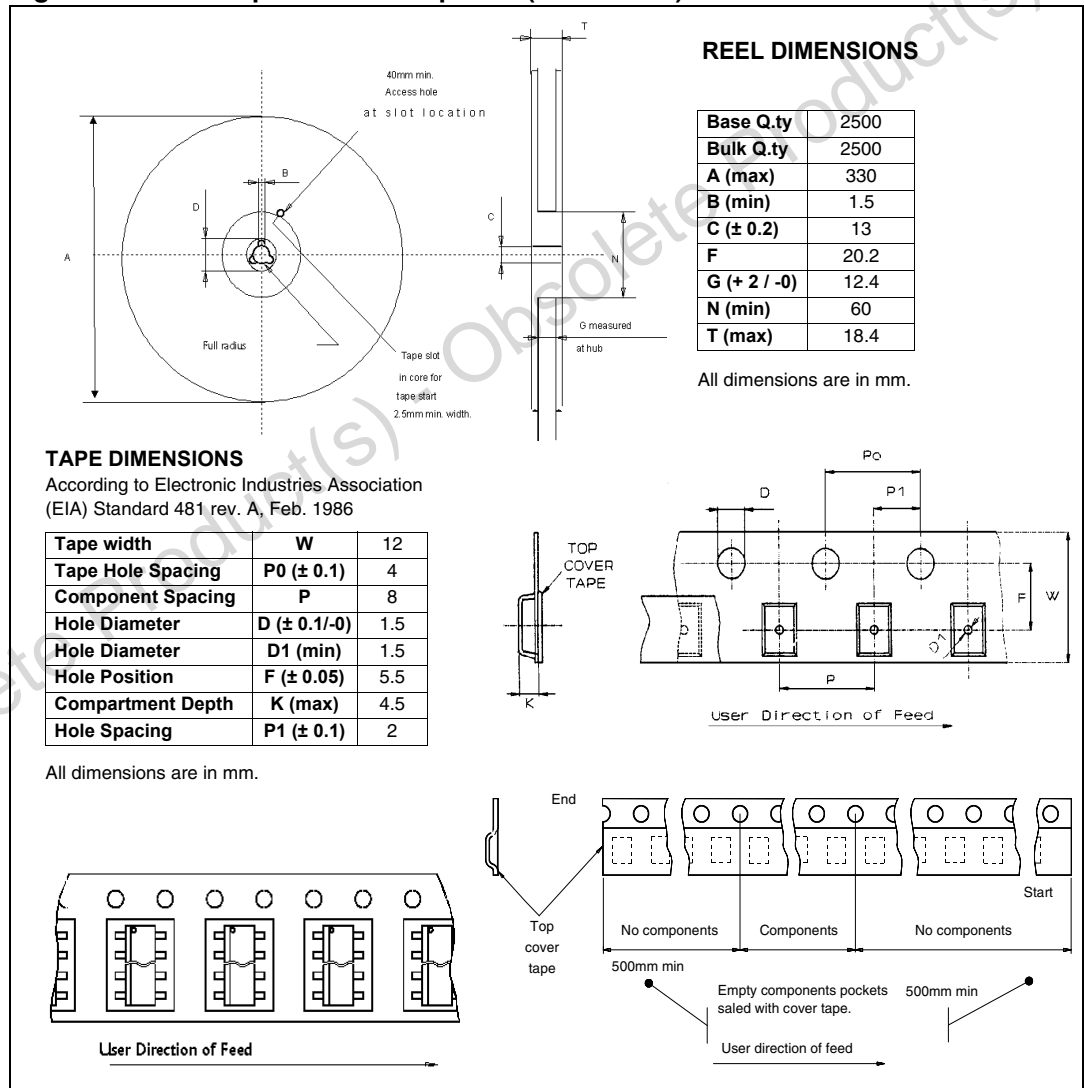

Figure 32. SO-8 Tape and reel shipment (suffix "TR")



5 Revision history

Table 10. Document revision history

Date	Revision	Changes
28-Oct-2005	1	Initial release.
25-Jun-2007	2	Document reformatted and converted into new ST template. <i>Table 4: Off</i> - I _{DSS} unit corrected
25-Sep-2013	3	Updated disclaimer.

Obsolete Product(s) - Obsolete Product(s)

Please Read Carefully:

Information in this document is provided solely in connection with ST products. STMicroelectronics NV and its subsidiaries ("ST") reserve the right to make changes, corrections, modifications or improvements, to this document, and the products and services described herein at any time, without notice.

All ST products are sold pursuant to ST's terms and conditions of sale.

Purchasers are solely responsible for the choice, selection and use of the ST products and services described herein, and ST assumes no liability whatsoever relating to the choice, selection or use of the ST products and services described herein.

No license, express or implied, by estoppel or otherwise, to any intellectual property rights is granted under this document. If any part of this document refers to any third party products or services it shall not be deemed a license grant by ST for the use of such third party products or services, or any intellectual property contained therein or considered as a warranty covering the use in any manner whatsoever of such third party products or services or any intellectual property contained therein.

UNLESS OTHERWISE SET FORTH IN ST'S TERMS AND CONDITIONS OF SALE ST DISCLAIMS ANY EXPRESS OR IMPLIED WARRANTY WITH RESPECT TO THE USE AND/OR SALE OF ST PRODUCTS INCLUDING WITHOUT LIMITATION IMPLIED WARRANTIES OF MERCHANTABILITY, FITNESS FOR A PARTICULAR PURPOSE (AND THEIR EQUIVALENTS UNDER THE LAWS OF ANY JURISDICTION), OR INFRINGEMENT OF ANY PATENT, COPYRIGHT OR OTHER INTELLECTUAL PROPERTY RIGHT.

ST PRODUCTS ARE NOT DESIGNED OR AUTHORIZED FOR USE IN: (A) SAFETY CRITICAL APPLICATIONS SUCH AS LIFE SUPPORTING, ACTIVE IMPLANTED DEVICES OR SYSTEMS WITH PRODUCT FUNCTIONAL SAFETY REQUIREMENTS; (B) AERONAUTIC APPLICATIONS; (C) AUTOMOTIVE APPLICATIONS OR ENVIRONMENTS, AND/OR (D) AEROSPACE APPLICATIONS OR ENVIRONMENTS. WHERE ST PRODUCTS ARE NOT DESIGNED FOR SUCH USE, THE PURCHASER SHALL USE PRODUCTS AT PURCHASER'S SOLE RISK, EVEN IF ST HAS BEEN INFORMED IN WRITING OF SUCH USAGE, UNLESS A PRODUCT IS EXPRESSLY DESIGNATED BY ST AS BEING INTENDED FOR "AUTOMOTIVE, AUTOMOTIVE SAFETY OR MEDICAL" INDUSTRY DOMAINS ACCORDING TO ST PRODUCT DESIGN SPECIFICATIONS. PRODUCTS FORMALLY ESCC, QML OR JAN QUALIFIED ARE DEEMED SUITABLE FOR USE IN AEROSPACE BY THE CORRESPONDING GOVERNMENTAL AGENCY.

Resale of ST products with provisions different from the statements and/or technical features set forth in this document shall immediately void any warranty granted by ST for the ST product or service described herein and shall not create or extend in any manner whatsoever, any liability of ST.

ST and the ST logo are trademarks or registered trademarks of ST in various countries.

Information in this document supersedes and replaces all information previously supplied.

The ST logo is a registered trademark of STMicroelectronics. All other names are the property of their respective owners.

© 2013 STMicroelectronics - All rights reserved

STMicroelectronics group of companies

Australia - Belgium - Brazil - Canada - China - Czech Republic - Finland - France - Germany - Hong Kong - India - Israel - Italy - Japan - Malaysia - Malta - Morocco - Philippines - Singapore - Spain - Sweden - Switzerland - United Kingdom - United States of America

www.st.com